



**I** ATTENZIONE: LA SICUREZZA DELL'APPARECCHIO E' GARANTITA SOLO CON L'USI APPROPRIATO DELLE SEGUENTI ISTRUZIONI. CONSERVARLE CON CURA.

Prima di eseguire qualsiasi tipo di operazione togliere la tensione di rete  
Per la pulizia dei vetri si raccomanda di non usare mai abrasivi o solventi  
Fare attenzione a non superare il Max di watt indicati per l'apparecchio  
L'apparecchio non può essere usato in ambienti umidi o all'esterno  
Mai coprire l'apparecchio durante l'impiego.  
Se il cavo flessibile esterno di questo apparecchio viene danneggiato, deve essere sostituito dal costruttore o dal suo servizio di assistenza, o da personale qualificato equivalente, al fine di evitare pericoli

Max. potenza lampada 36W-24Vdc  
Attacco lampada LED 3000K  
Tipo lampada   
Apparecchio classe |  
Grado di protezione IP40

**GB** ATTENTION: THE SAFETY OF THE APPLIANCE IS GUARANTEED ONLY IF IT IS PROPERLY USED, ACCORDING TO THE FOLLOWING INSTRUCTIONS, WHICH ARE TO BE KEPT.

Always disconnect the power supply before installing or performing any maintenance operations  
For cleaning the glass do not use any abrasive or solvent materials  
Make attention of not exceeding the maximum watt indicated on the appliance  
The appliance may not be used in humid or external environments  
Never cover the appliance while in function  
If the external flexible cable or cord of this luminaire is damaged, it shall be exclusively replaced by the manufacturer or his service agent or a similar qualified person in order to avoid a hazard

Capacity of bulb 36W-24Vdc  
Type of lampholder LED 3000K  
Type of bulb   
Appliance in class |  
Protection class IP40

**D** ACHTUNG: DIE SICHERHEIT DIESES BELEUCHTUNGSKÖRPERS WIRD NUR DURCH DIE KORREKTE ANWENDUNG DER NACHSTEHENDEN ANWEISUNGEN GEWÄHRLEISTET. DIESE ÜSSEN DAHER SORGFÄLTIG AUFBEWAHRT WERDEN.:

Bevor irgendwelche Arbeitsgänge ausgeführt werden, muß die Stromversorgung unterbrochen  
Zur Reinigung der Gläser dürfen keine Scheuer- bzw. Lösungsmittel verwendet werden  
Achten Sie darauf, daß die auf dem Beleuchtungskörper angegebene maximale Wattzahl nicht überschritten wird  
Der Beleuchtungskörper darf nicht in feuchten Räumen bzw. im Freien eingesetzt werden  
Den Beleuchtungskörper während dem Betrieb nicht abdecken  
Wenn das äußere, flexible Kabel beschädigt sein sollte, darf es nur durch den Lieferanten, durch den Kundenservice oder von Fachleuten ausgetauscht werden, um Schäden und Gefahren zu vermeiden

Leistung der Gluehbirne 36W-24Vdc  
Anschluss LED 3000K  
Typ der Gluehbirne   
Gerät der Klasse |  
Schutzklasse IP40

**RU** ВНИМАНИЕ: БЕЗОПАСНОСТЬ ОСВЕТИТЕЛЬНОГО ПРИБОРА ГАРАНТИРОВАНА ТОЛЬКО ПРИ УСЛОВИИ ЕГО ЭКСПЛУАТАЦИИ В СООТВЕТСТВИИ С ПРИВЕДЕННЫМИ НИЖЕ ИНСТРУКЦИЯМИ, КОТОРЫЕ НЕОБХОДИМО СОХРАНИТЬ.

Перед выполнением любой операции с осветительным прибором отключить напряжение в сети  
Рекомендуется никогда не чистить стекло при употреблении абразивных веществ или Растворителей  
Не превышать максимально допустимую мощность, указанную для данного осветительного прибора  
Осветительный прибор не может быть использован во влажных помещениях или на улице  
Никогда не накрывать осветительный прибор в рабочем режиме  
Для того чтобы избежать опасностей в случае повреждения наружного гибкого кабеля, этот элемент должен заменить только строитель, или послепродажное обслуживание – или квалифицированный персонал

Максимальная мощность лампочки 36W-24Vdc  
Тип цоколя лампочки LED 3000K  
Тип лампочки   
Осветительный прибор КЛАССА |  
Класс защиты IP40

**F** ATTENTION: LA SÉCURITÉ DE CET APPAREIL N'EST GARANTIE QUE SI L'ON RESPECTE LES INSTRUCTIONS SUIVANTES. IL EST, PAR CONSÉQUENT, INDISPENSABLE DE LES CONSERVER SOIGNEUSEMENT.

Avant d'effectuer toute opération, débrancher la tension de réseau  
Ne jamais utiliser des abrasifs ou des solvants pour le nettoyage des parties en verre  
Veiller à ne pas dépasser la limite maximale des watts indiquée sur l'appareil  
Cet appareil ne peut pas être utilisé dans des pièces humides ni à l'extérieur  
Ne jamais couvrir l'appareil pendant son fonctionnement  
Si vient endommagé le câble électrique flexible, il doit être remplacé par le constructeur ou par des techniciens qualifiés et compétents pour éviter tout danger

Puissance ampoule 36W-24Vdc  
Culot LED 3000K  
Type ampoule   
Appareil de classe |  
Classe de protection IP40

**P** ATENÇÃO: A SEGURANÇA DO APARELHO É GARANTIDA SOMENTE SE FOREM RESPEITADAS AS INSTRUÇÕES. PORTANTO, É NECESSÁRIO CONSERVÁ-LAS.

Antes de fazer qualquer tipo de operação, desligar a corrente eléctrica da rede  
Para limpeza do vidro não usar materiais abrasivos ou solventes  
Prestar atenção para não superar o número de watts indicados para o aparelho  
O aparelho não pode ser utilizado em ambientes húmidos ou no exterior  
Nunca cobrir o aparelho durante o funcionamento  
Se os cabos eléctricos externos ou cabos de sustentação estiverem danificados, devem ser trocados exclusivamente pelo fabricante, assistente técnico ou por profissional qualificado com objetivo de evitar danos maiores

Potência máxima da lâmpada 36W-24Vdc  
Tipo de suporte da lâmpada LED 3000K  
Tipo de lâmpada   
Aparelho de CLASSE |  
Classe de protecção IP40

**E** ATENCIÓN: LA SEGURIDAD DEL APARATO ESTÁ GARANTIZADA SÓLO POR UN USO ADECUADO DE LAS SIGUIENTES INSTRUCCIONES; POR CONSIGUIENTE, ES PRECISO CONSERVARLAS.

Antes de llevar a cabo cualquier tipo de operación, desconectar la tensión de la red  
Para limpiar el cristal no utilice ningún abrasivo o solvente  
Prestar atención a no superar el máximo de los vatios indicados en el aparato  
El aparato no podrá utilizarse en ambientes húmedos ni en exteriores  
No cubrir jamás el aparato durante el funcionamiento  
En caso de que el cable exterior flexible se dane, debe ser cambiado por el fabricante o su servicio de asistencia o personas cualificadas a fin de evitar peligros

Potencia máxima de la bombilla 36W-24Vdc  
Casquillo de la bombilla LED 3000K  
Tipo de bombilla   
Aparato CLASE |  
Clase de protección IP40

- I - Procedere al montaggio seguendo le operazioni in ordine numerico progressivo.
- GB - Proceed with assembling following the operations in progressive numerical order.
- D - Arbeitsgänge in numerischer ordnung ausführen, um das gerät zu installieren.
- RU - Производите установку в порядке увеличения обозначенных выше номеров.
- F - Il faut procéder a le montage exécutant les operatoins par l'ordre numerique progressif.
- P - Proceder a montagem segundo as instruções em ordem numerica progressiva.
- ES - Proceder al montaje siguiendo las operaciones en orden numerico progresivo.

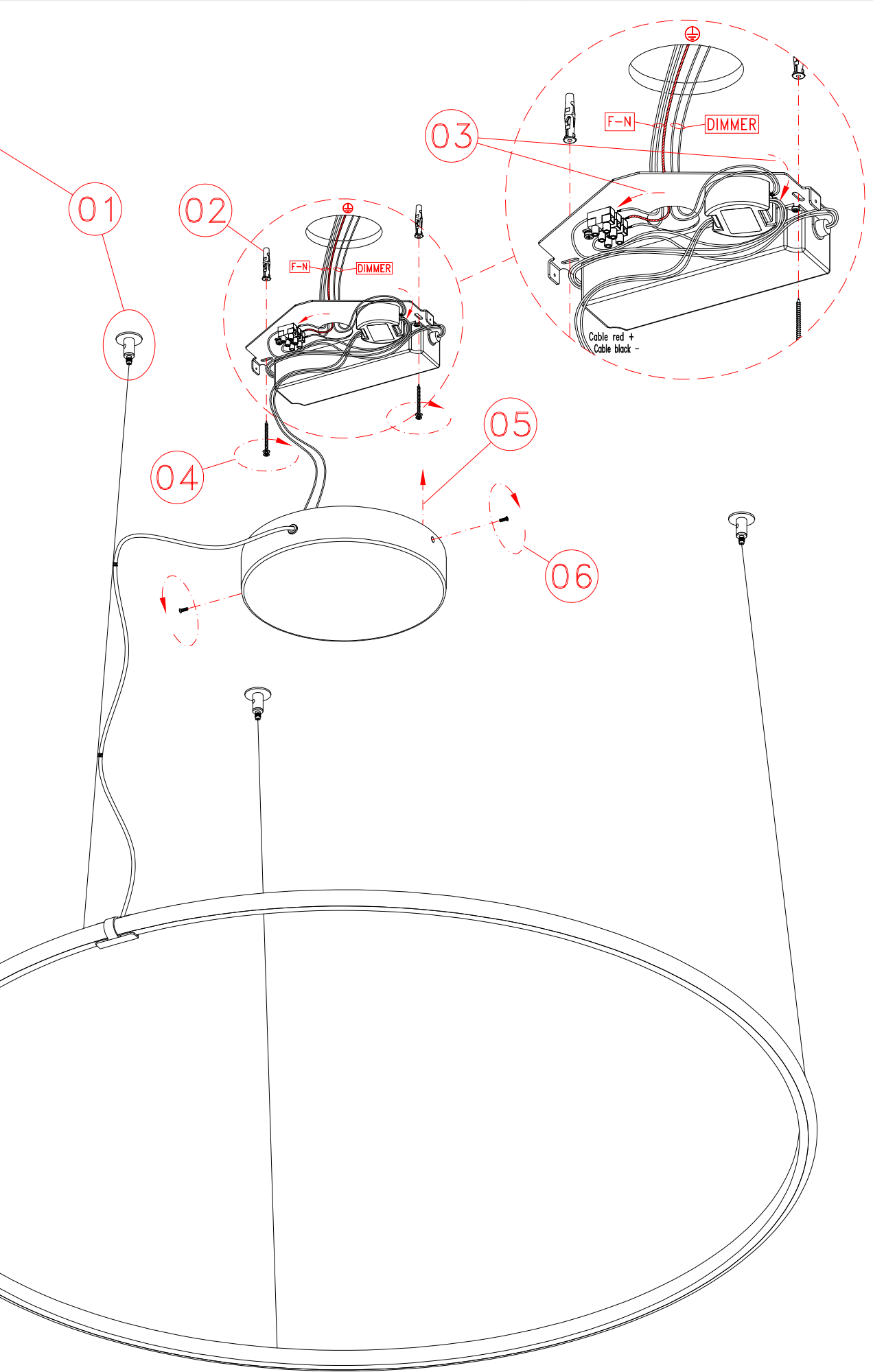
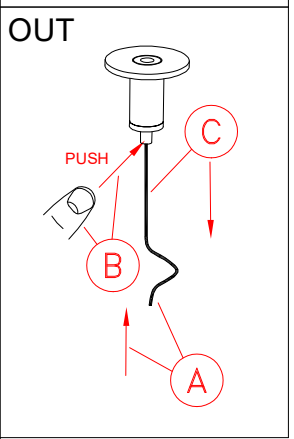
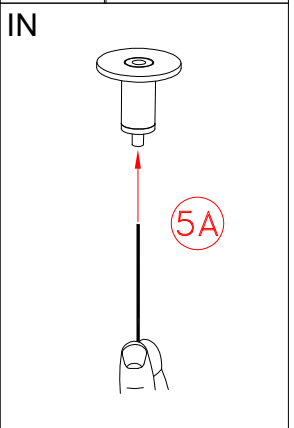
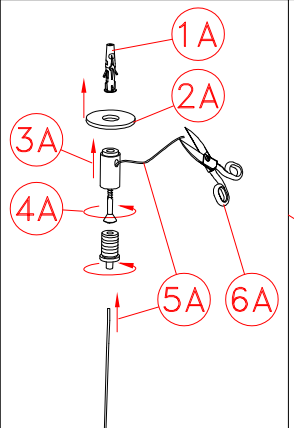



**FEATURES**

- BUS+FADE+DIMMER+DRIVER
- DC input: DC 12-24-48 Vdc or 12-24Vdc
- BUS Command:
  - DALI
  - DMX512+RDM
- MULTI INPUT – Analogic Automatic Detection of the Local Command:
  - Normally Open Push-Button
  - 1-10V
  - Potentiometer 10KOhm
- PUSH MENU – Possibility to set:
  - Minimum value or dimming
  - Fade In
  - Fade Out
- Constant voltage variant to Common Anode applications
- Voltage outputs for R-L-C loads, DLM1248-1CV-DALI or DMX
- Voltage outputs for R loads, DLM1224-1CV-DALI or DMX
- Memory function
- Adjusting the brightness of White light or monochromatic color
- Adjusting the brightness up to completed off
- Soft start and soft stop
- Optimized output curve
- Typical efficiency > 95%
- 100% Functional test – 5 Years warranty



**CONSTANT VOLTAGE VARIANTS**

Application: Dimmer

| CODE             | Input Voltage | Output   | Channels | BUS Command | Analogic Auto Detection                               |
|------------------|---------------|----------|----------|-------------|---|
| DLM1248-1CV-DALI | 12-48V DC     | 1 x 6.5A | 1        | DALI        | N° 1 N.O. Push Button<br>N° 1 analog signal 0-10V     |
| DLM1224-1CV-DALI | 12-24V DC     | 1 x 10A  | 1        | DALI        | N° 1 analog signal 1-10V<br>N° 1 potentiometer 10KOhm |
| DLM1248-1CV-DMX  | 12-48V DC     | 1 x 6.5A | 1        | DMX         | N° 1 N.O. Push Button<br>N° 1 analog signal 0-10V     |
| DLM1224-1CV-DMX  | 12-24V DC     | 1 x 10A  | 1        | DMX         | N° 1 analog signal 1-10V<br>N° 1 potentiometer 10KOhm |

The LED Dimmer is produced by default with:  
 - Analog Automatic Detection of local command set as N.O. Push Button  
 - Dimming minimum level at 1%

**PROTECTIONS**

|     | DLM1248-1CV-DALI/DMX             | DLM1224-1CV-DALI/DMX |
|-----|----------------------------------|----------------------|
| OTP | Over temperature protection (*)  | ✓                    |
| OVP | Over voltage protection (**)     | ✓                    |
| UVP | Under voltage protection (**)    | ✓                    |
| RVP | Reverse polarity protection (**) | ✓                    |
| IIP | Input fuse protection (**)       | ✓                    |
| SCP | Short circuit protection         | ✓                    |
| OCP | Open circuit protection          | ✓                    |
| CLP | Current limit protection         | ✓                    |

(\*) Thermal Protection on the output channel in case of high temperature. The thermal intervention is detected by transistor (> 150°C)  
 (\*\*) Only control logic protection

**REFERENCE STANDARDS**

|                  |   |
|------------------|---|
| EN 61347-1       | Lamp controlgear - Part 1: General and safety requirements  |
| EN 55015         | Limits and methods of measurement of radio disturbance characteristics of electrical lighting and similar equipment                                   |
| EN 61547         | Equipment for general lighting purposes - EMC immunity requirements   |
| IEC/EN 62386-101 | Digital addressable lighting interface - Part 101: General requirements - System  |
| IEC/EN 62386-102 | Digital addressable lighting interface - Part 102: General requirements - Control gear  |
| IEC 60929-E.2.1  | Digital addressable lighting interface - Part 207: Particular requirements for control gear - LED modules (device type 6)                             |
| ANSI E 1.3       | Control interface for controllable ballasts - control by d.c. voltage - functional specification  |
| ANSI E1.11       | Entertainment Technology - Lighting Control Systems - 0 to 10V Analog Control Specification   |
| ANSI E1.20       | Entertainment Technology - USITT DMX512-A - Asynchronous Serial Digital Data Transmission Standard for Controlling Lighting Equipment and Accessories |
| ANSI E1.20       | Entertainment Technology-RDM-Remote Device Management over USITT DMX512 Networks  |

**TECHNICAL SPECIFICATIONS**

|                                      | DLM1248-1CV DALI or DMX Variant                                    | DLM1224-1CV DALI or DMX Variant                                  |
|--------------------------------------|--|--|
| Supply voltage                       | Constant voltage<br>min: 10,8 Vdc .. max: 52,8 Vdc                 | Constant voltage<br>min: 10,8 Vdc .. max: 26,4 Vdc               |
| Output voltage                       | = Vin  | = Vin  |
| Output current                       | 6,5A @40°C <sup>1)</sup>   | 10A @40°C <sup>2)</sup>  |
| Absorbed nominal power <sup>3)</sup> | 78 W<br>156 W<br>312 W   | 120 W<br>240 W   |
| Power loss in stand by mode          | <500mW   | <500mW   |
| Type of Load                         | R - L - C  | R  |
| Thermal shutdown <sup>3)</sup>       | 150°C  | -  |
| D-PWM dimming frequency              | 300Hz  | 300Hz  |
| D-PWM resolution                     | 16 bit   | 16 bit   |
| D-PWM range                          | 0,1 - 100 %  | 0,1 - 100 %  |
| Storage Temperature                  | min: -40 max: +60 °C   | min: -40 max: +60 °C   |
| Ambient Temperature <sup>3)</sup>    | min: -10 max: +40 °C   | min: -10 max: +40 °C   |
| Protection grade                     | IP20   | IP20   |
| Wiring                               | 2,5mm <sup>2</sup> solid - 2,5mm <sup>2</sup> stranded - 30/12 AWG | 1,5mm <sup>2</sup> solid - 1mm <sup>2</sup> stranded - 30/16 AWG |
| Wire preparation length              | 5,5 + 6,5 mm   | 5 + 6mm  |
| Mechanical dimensions                | 44 x 57 x 25 mm  | 44 x 57 x 19 mm  |
| Package dimensions                   | 56 x 68 x 35 mm  | 56 x 68 x 35 mm  |
| Casing material                      | Plastic  | Plastic  |
| Weight                               | 43g  | 37g  |

<sup>1)</sup> maximum value, dependent on the ventilation conditions. This value is measured at 40°C, it is maximum ambient temperature.  
<sup>2)</sup>The Temperature Protection, in case of high temperature, is detected by transistor (> 150°C) and is only on the output channel.

