



I ATTENZIONE: LA SICUREZZA DELL'APPARECCHIO E' GARANTITA SOLO CON L'USI APPROPRIATO DELLE SEGUENTI ISTRUZIONI. CONSERVARLE CON CURA.

Prima di eseguire qualsiasi tipo di operazione togliere la tensione di rete
Per la pulizia dei vetri si raccomanda di non usare mai abrasivi o solventi
Fare attenzione a non superare il Max di watt indicati per l'apparecchio
L'apparecchio non può essere usato in ambienti umidi o all'esterno
Mai coprire l'apparecchio durante l'impiego.
Se il cavo flessibile esterno di questo apparecchio viene danneggiato, deve essere sostituito dal costruttore o dal suo servizio di assistenza, o da personale qualificato equivalente, al fine di evitare pericoli

Max. potenza lampada 98W-24Vdc
Attacco lampada LED 2700K
Tipo lampada 
Apparecchio classe **I**
Grado di protezione **IP40**

GB ATTENTION: THE SAFETY OF THE APPLIANCE IS GUARANTEED ONLY IF IT IS PROPERLY USED, ACCORDING TO THE FOLLOWING INSTRUCTIONS, WHICH ARE TO BE KEPT.

Always disconnect the power supply before installing or performing any maintenance operations
For cleaning the glass do not use any abrasive or solvent materials
Make attention of not exceeding the maximum watt indicated on the appliance
The appliance may not be used in humid or external environments
Never cover the appliance while in function
If the external flexible cable or cord of this luminaire is damaged, it shall be exclusively replaced by the manufacturer or his service agent or a similar qualified person in order to avoid a hazard

Capacity of bulb 98W-24Vdc
Type of lampholder LED 2700K
Type of bulb 
Appliance in class **I**
Protection class **IP40**

D ACHTUNG: DIE SICHERHEIT DIESES BELEUCHTUNGSKÖRPERS WIRD NUR DURCH DIE KORREKTE ANWENDUNG DER NACHSTEHENDEN ANWEISUNGEN GEWÄHRLEISTET. DIESE ÜSSEN DAHER SORGFÄLTIG AUFBEWAHRT WERDEN.:

Bevor irgendwelche Arbeitsgänge ausgeführt werden, muß die Stromversorgung unterbrochen
Zur Reinigung der Gläser dürfen keine Scheuer- bzw. Lösungsmittel verwendet werden
Achten Sie darauf, daß die auf dem Beleuchtungskörper angegebene maximale Wattzahl nicht überschritten wird
Der Beleuchtungskörper darf nicht in feuchten Räumen bzw. im Freien eingesetzt werden
Den Beleuchtungskörper während dem Betrieb nicht abdecken
Wenn das äußere, flexible Kabel beschädigt sein sollte, darf es nur durch den Lieferanten, durch den Kundenservice oder von Fachleuten ausgetauscht werden, um Schäden und Gefahren zu vermeiden

Leistung der Gluehbirne 98W-24Vdc
Anschluss LED 2700K
Typ der Gluehbirne 
Gerät der Klasse **I**
Schutzklasse **IP40**

RU ВНИМАНИЕ: БЕЗОПАСНОСТЬ ОСВЕТИТЕЛЬНОГО ПРИБОРА ГАРАНТИРОВАНА ТОЛЬКО ПРИ УСЛОВИИ ЕГО ЭКСПЛУАТАЦИИ В СООТВЕТСТВИИ С ПРИВЕДЕННЫМИ НИЖЕ ИНСТРУКЦИЯМИ, КОТОРЫЕ НЕОБХОДИМО СОХРАНИТЬ.

Перед выполнением любой операции с осветительным прибором отключить напряжение в сети
Рекомендуется никогда не чистить стекло при употреблении абразивных веществ или Растворителей
Не превышать максимально допустимую мощность, указанную для данного осветительного прибора
Осветительный прибор не может быть использован во влажных помещениях или на улице
Никогда не накрывать осветительный прибор в рабочем режиме
Для того чтобы избежать опасностей в случае повреждения наружного гибкого кабеля, этот элемент должен заменить только строитель, или послепродажное обслуживание – или квалифицированный персонал

Максимальная мощность лампочки 98W-24Vdc
Тип цоколя лампочки LED 2700K
Тип лампочки 
Осветительный прибор КЛАССА **I**
Класс защиты **IP40**

F ATTENTION: LA SÉCURITÉ DE CET APPAREIL N'EST GARANTIE QUE SI L'ON RESPECTE LES INSTRUCTIONS SUIVANTES. IL EST, PAR CONSÉQUENT, INDISPENSABLE DE LES CONSERVER SOIGNEUSEMENT.

Avant d'effectuer toute opération, débrancher la tension de réseau
Ne jamais utiliser des abrasifs ou des solvants pour le nettoyage des parties en verre
Veiller à ne pas dépasser la limite maximale des watts indiquée sur l'appareil
Cet appareil ne peut pas être utilisé dans des pièces humides ni à l'extérieur
Ne jamais couvrir l'appareil pendant son fonctionnement
Si vient endommagé le câble électrique flexible, il doit être remplacé par le constructeur ou par des techniciens qualifiés et compétents pour éviter tout danger

Puissance ampoule 98W-24Vdc
Culot LED 2700K
Type ampoule 
Appareil de classe **I**
Classe de protection **IP40**

P ATENÇÃO: A SEGURANÇA DO APARELHO É GARANTIDA SOMENTE SE FOREM RESPEITADAS AS INSTRUÇÕES. PORTANTO, É NECESSÁRIO CONSERVÁ-LAS.

Antes de fazer qualquer tipo de operação, desligar a corrente eléctrica da rede
Para limpeza do vidro não usar materiais abrasivos ou solventes
Prestar atenção para não superar o número de watts indicados para o aparelho
O aparelho não pode ser utilizado em ambientes húmidos ou no exterior
Nunca cobrir o aparelho durante o funcionamento
Se os cabos eléctricos externos ou cabos de sustentação estiverem danificados, devem ser trocados exclusivamente pelo fabricante, assistente técnico ou por profissional qualificado com objetivo de evitar danos maiores

Potência máxima da lâmpada 98W-24Vdc
Tipo de suporte da lâmpada LED 2700K
Tipo de lâmpada 
Aparelho de CLASSE **I**
Classe de protecção **IP40**

E ATENCIÓN: LA SEGURIDAD DEL APARATO ESTÁ GARANTIZADA SÓLO POR UN USO ADECUADO DE LAS SIGUIENTES INSTRUCCIONES; POR CONSIGUIENTE, ES PRECISO CONSERVARLAS.

Antes de llevar a cabo cualquier tipo de operación, desconectar la tensión de la red
Para limpiar el cristal no utilice ningún abrasivo o solvente
Prestar atención a no superar el máximo de los vatios indicados en el aparato
El aparato no podrá utilizarse en ambientes húmedos ni en exteriores
No cubrir jamás el aparato durante el funcionamiento
En caso de que el cable exterior flexible se dane, debe ser cambiado por el fabricante o su servicio de asistencia o personas cualificadas a fin de evitar peligros

Potencia máxima de la bombilla 98W-24Vdc
Casquillo de la bombilla LED 2700K
Tipo de bombilla 
Aparato CLASE **I**
Clase de protección **IP40**

- ① - Procedere al montaggio seguendo le operazioni in ordine numerico progressivo.
- GB - Proceed with assembling following the operations in progressive numerical order.
- ② - Arbeitsgänge in numerischer ordnung ausführen, um das gerät zu installieren.
- RU - Производите установку в порядке увеличения обозначенных выше номеров.
- ③ - Il faut procéder a le montage exécutant les operatoins par l'ordre numerique progressif.
- ④ - Proceder a montagem segundo as instruções em ordem numerica progressiva.
- ES - Proceder al montaje siguiendo las operaciones en orden numerico progresivo.

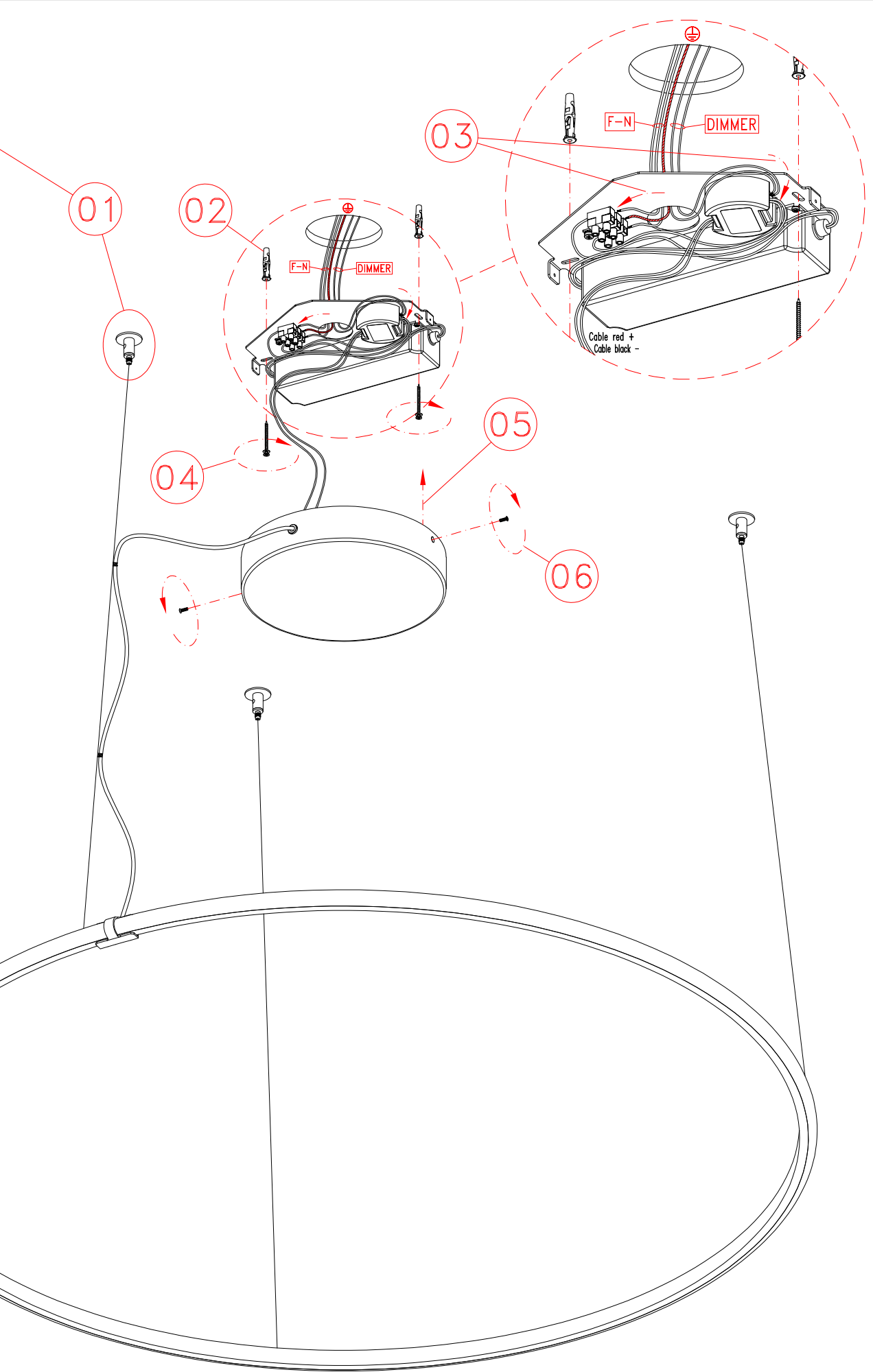
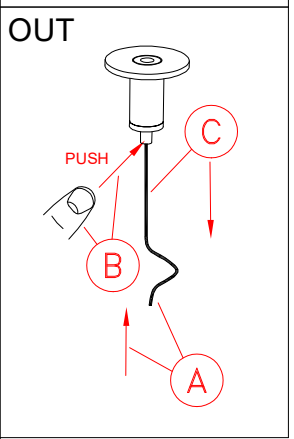
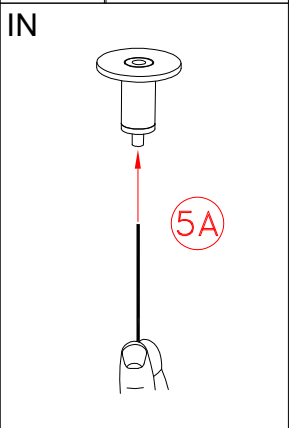
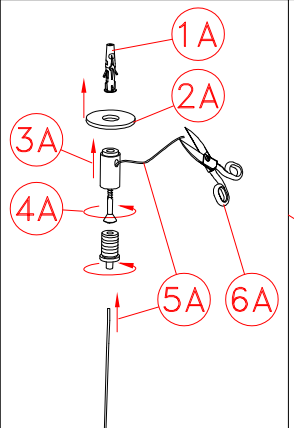

Mechanical Specification

Case No. 999A Unit:mm

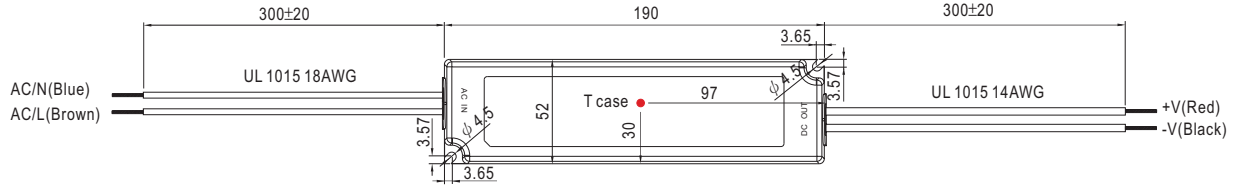

※ T case: Max. Case Temperature.

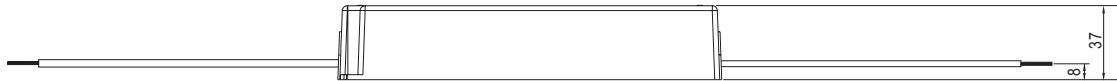

Recommend Mounting Direction

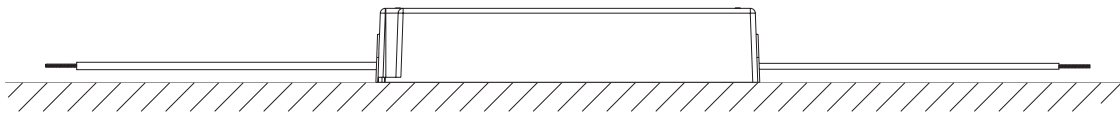

Block Diagram

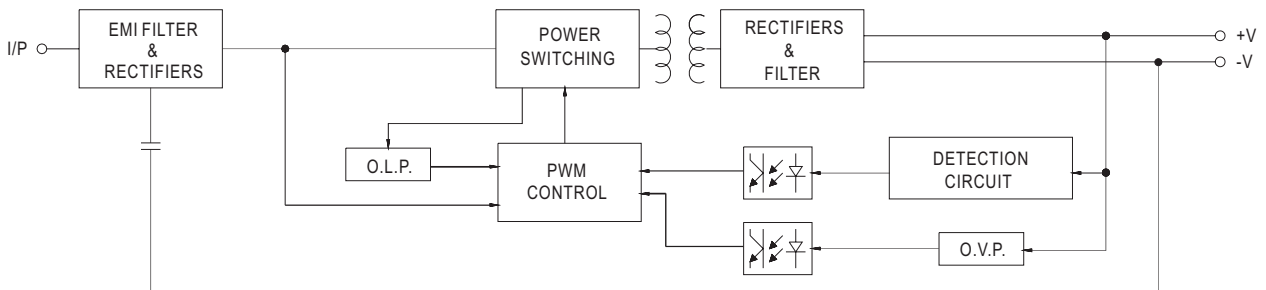

Derating Curve

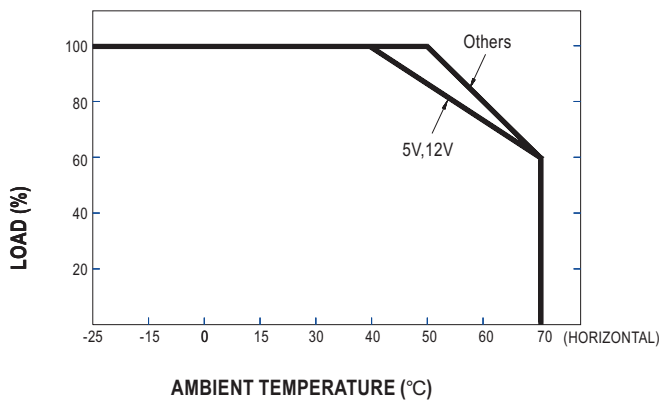

Static Characteristics

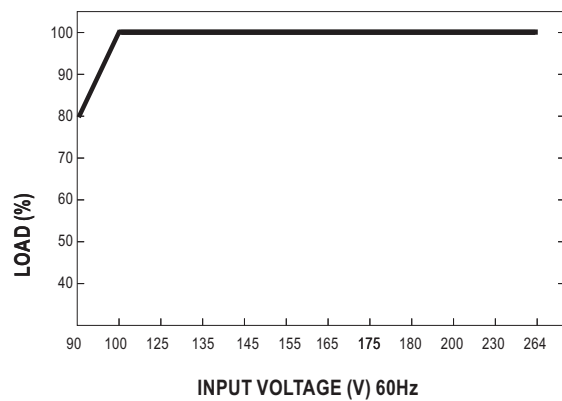



FEATURES

- BUS+FADER+DIMMER+DRIVER
- DC input: DC 12-24-48 Vdc or 12-24Vdc
- BUS Command:
 - DALI
 - DMX512+RDM
- MULTI INPUT – Analogic Automatic Detection of the Local Command:
 - Normally Open Push-Button
 - 1-10V
 - Potentiometer 10KOhm
- PUSH MENU – Possibility to set:
 - Minimum value or dimming
 - Fade In
 - Fade Out
- Constant voltage variant to Common Anode applications
- Voltage outputs for R-L-C loads, DLM1248-1CV-DALI or DMX
- Voltage outputs for R loads, DLM1224-1CV-DALI or DMX
- Memory function
- Adjusting the brightness of White light or monochromatic color
- Adjusting the brightness up to completed off
- Soft start and soft stop
- Optimized output curve
- Typical efficiency > 95%
- 100% Functional test – 5 Years warranty



CONSTANT VOLTAGE VARIANTS

Application: Dimmer

CODE	Input Voltage	Output	Channels	BUS Command	Analogic Auto Detection
DLM1248-1CV-DALI	12-48V DC	1 x 6.5A	1	DALI	N° 1 N.O. Push Button N° 1 analog signal 0-10V
DLM1224-1CV-DALI	12-24V DC	1 x 10A	1	DALI	N° 1 analog signal 1-10V N° 1 potentiometer 10KOhm
DLM1248-1CV-DMX	12-48V DC	1 x 6.5A	1	DMX	N° 1 N.O. Push Button N° 1 analog signal 0-10V
DLM1224-1CV-DMX	12-24V DC	1 x 10A	1	DMX	N° 1 analog signal 1-10V N° 1 potentiometer 10KOhm

The LED Dimmer is produced by default with:
 - Analog Automatic Detection of local command set as N.O. Push Button
 - Dimming minimum level at 1%

PROTECTIONS

	DLM1248-1CV-DALI/DMX	DLM1224-1CV-DALI/DMX
OTP	Over temperature protection (*)	✓
OVP	Over voltage protection (**)	✓
UVP	Under voltage protection (**)	✓
RVP	Reverse polarity protection (**)	✓
IIP	Input fuse protection (**)	✓
SCP	Short circuit protection	✓
OC	Open circuit protection	✓
CLP	Current limit protection	✓

(*) Thermal Protection on the output channel in case of high temperature. The thermal intervention is detected by transistor (> 150°C)

(**) Only control logic protection

REFERENCE STANDARDS

EN 61347-1	Lamp controlgear - Part 1: General and safety requirements
EN 55015	Limits and methods of measurement of radio disturbance characteristics of electrical lighting and similar equipment
EN 61547	Equipment for general lighting purposes - EMC immunity requirements
IEC/EN 62386-101	Digital addressable lighting interface - Part 101: General requirements - System
IEC/EN 62386-102	Digital addressable lighting interface - Part 102: General requirements - Control gear
IEC 60929-E.2.1	Digital addressable lighting interface - Part 207: Particular requirements for control gear - LED modules (device type 6)
ANSI E 1.3	Control interface for controllable ballasts - control by d.c. voltage - functional specification
ANSI E1.11	Entertainment Technology - Lighting Control Systems - 0 to 10V Analog Control Specification
ANSI E1.20	Entertainment Technology - USITT DMX512-A - Asynchronous Serial Digital Data Transmission Standard for Controlling Lighting Equipment and Accessories
	Entertainment Technology-RDM-Remote Device Management over USITT DMX512 Networks

TECHNICAL SPECIFICATIONS

	DLM1248-1CV DALI or DMX Variant	DLM1224-1CV DALI or DMX Variant
Supply voltage	Constant voltage min: 10,8 Vdc .. max: 52,8 Vdc	Constant voltage min: 10,8 Vdc .. max: 26,4 Vdc
Output voltage	= Vin	= Vin
Output current	6,5A @40°C ¹⁾	10A @40°C ²⁾
Absorbed nominal power ³⁾	78 W 156 W 312 W	120 W 240 W
Power loss in stand by mode	<500mW	<500mW
Type of Load	R - L - C	R
Thermal shutdown ³⁾	150°C	-
D-PWM dimming frequency	300Hz	300Hz
D-PWM resolution	16 bit	16 bit
D-PWM range	0,1 - 100 %	0,1 - 100 %
Storage Temperature	min: -40 max: +60 °C	min: -40 max: +60 °C
Ambient Temperature ³⁾	min: -10 max: +40 °C	min: -10 max: +40 °C
Protection grade	IP20	IP20
Wiring	2,5mm ² solid - 2,5mm ² stranded - 30/12 AWG	1,5mm ² solid - 1mm ² stranded - 30/16 AWG
Wire preparation length	5,5 + 6,5 mm	5 + 6mm
Mechanical dimensions	44 x 57 x 25 mm	44 x 57 x 19 mm
Package dimensions	56 x 68 x 35 mm	56 x 68 x 35 mm
Casing material	Plastic	Plastic
Weight	43g	37g

¹⁾ maximum value, dependent on the ventilation conditions. This value is measured at 40°C, it is maximum ambient temperature.

²⁾The Temperature Protection, in case of high temperature, is detected by transistor (> 150°C) and is only on the output channel.

To set the product, follow the instruction on the picture below:
 1) connect the LED in the output terminal blocks "OUT" of the device.
 2) connect the LOCAL COMMAND to the terminal blocks "INPUT" and / or connect the BUS COMMAND to the terminal block "DALI or DMX" of the device.
 3) connect the power supply (12-24 Vdc or 12-48Vdc depending on the dimmer model) to terminal blocks "DC IN" of the device.

MECHANICAL DIMENSION
 DLM1224 1CV BUS Variant
 DLM1248 1CV BUS Variant

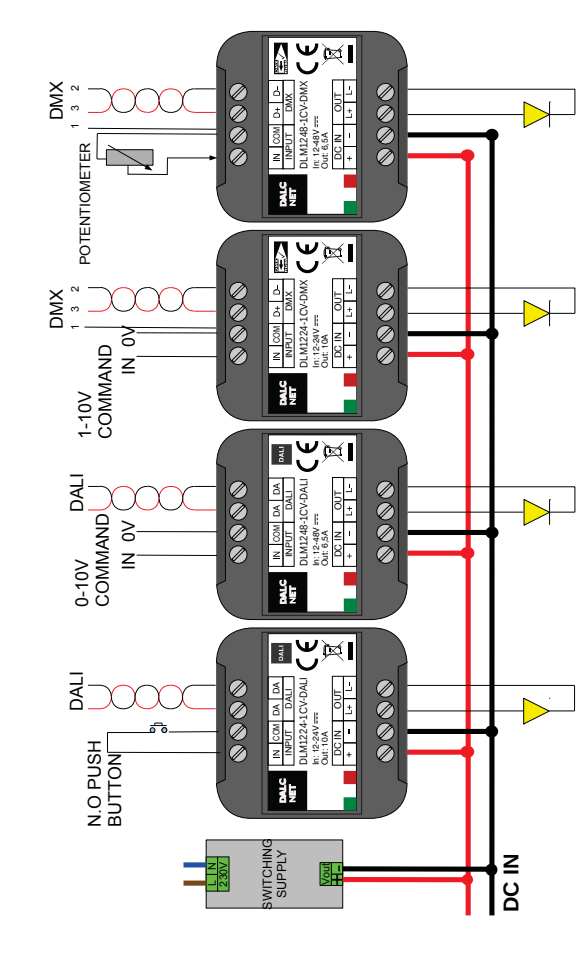

Examples of local commands and BUS command (DALI or DMX) connection.

